

国标30系列 ◀ 连接配件 挤压角座

系列码	材质	表面处理
XCCB01	A6063-T5	喷砂氧化

- 用于型材固定角度的外连接，可固定封板。
- 可来图定制。

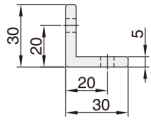

XCCB01-308-3020

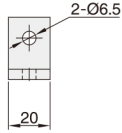

XCCB01-308-30350

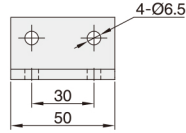

XCCB01-308-3080

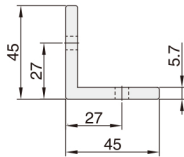
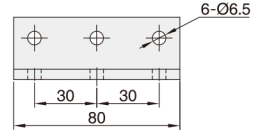

XCCB01-308-4520

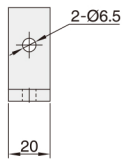

XCCB01-308-4550

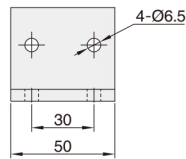

XCCB01-308-4580

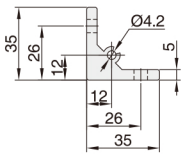
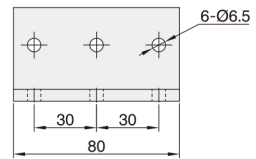

XCCB01-308-3520

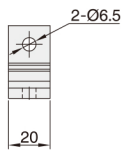

XCCB01-308-3550

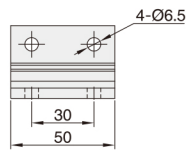

XCCB01-308-3580

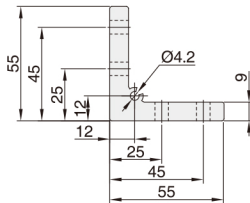
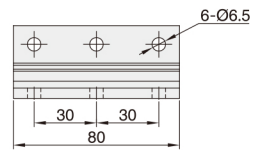

XCCB01-308-5520

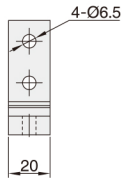

XCCB01-308-5550

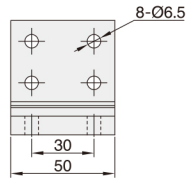

XCCB01-308-5580

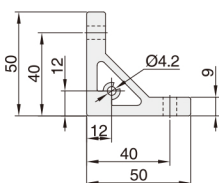
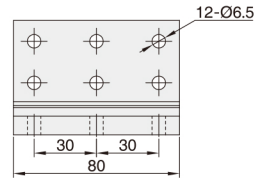

XCCB01-308-5020

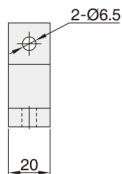

XCCB01-308-5050

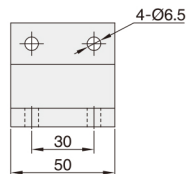

XCCB01-308-5080

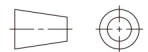
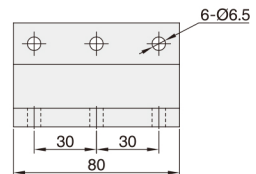

视图标准：第三视图

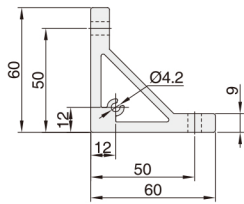

XCCB01-308-6020

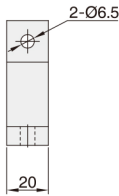

XCCB01-308-6050

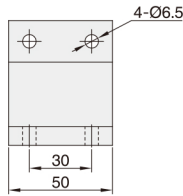

XCCB01-308-6080

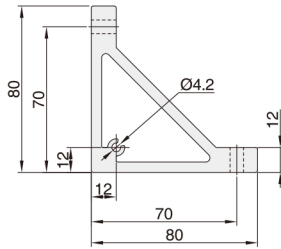
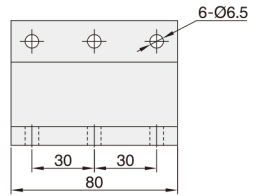

XCCB01-308-8020

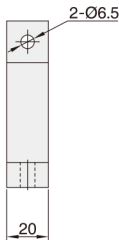

XCCB01-308-8050

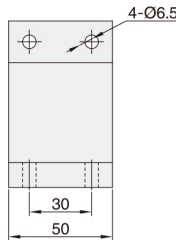

XCCB01-308-8080

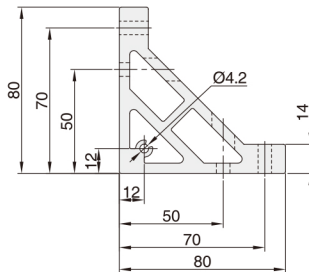
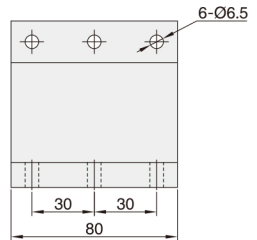

XCCB01-308-80B20

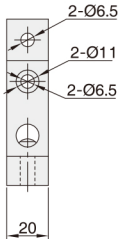

XCCB01-308-80B50

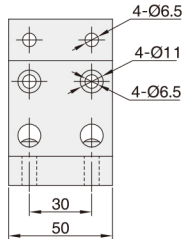

XCCB01-308-80B80

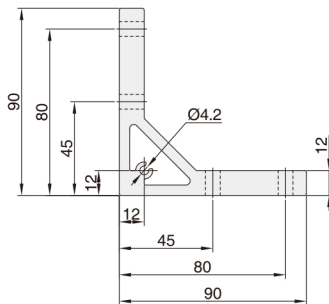
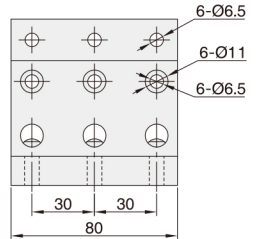

XCCB01-308-9020

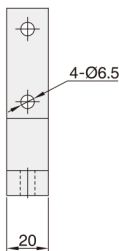

XCCB01-308-9050

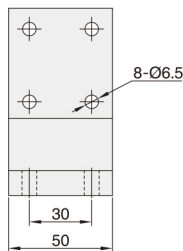

XCCB01-308-9080

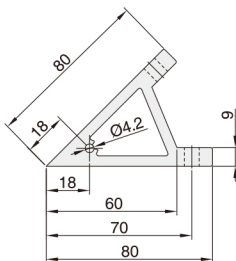
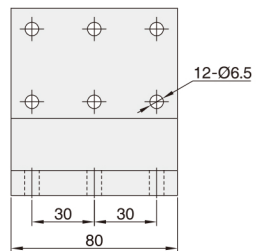

XCCB01-308-80A20

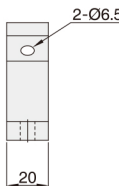

XCCB01-308-80A50

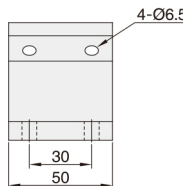

XCCB01-308-80A80

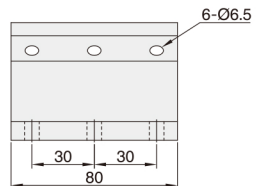

视图标准：第三视角

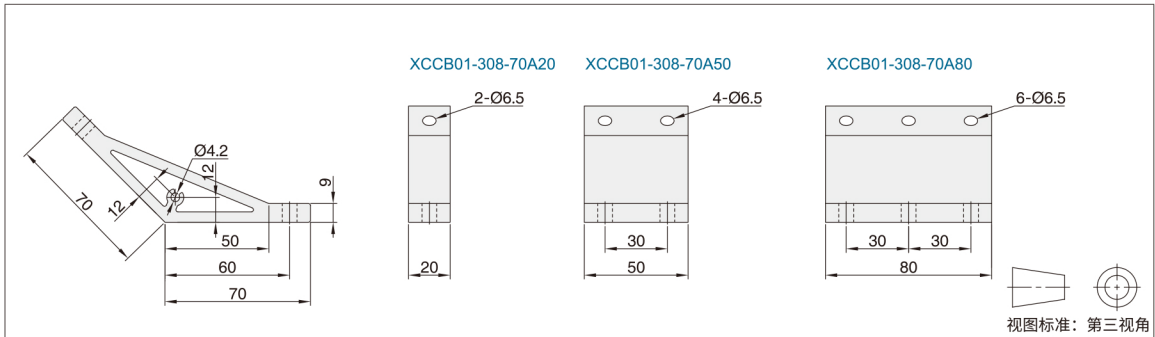

系列码	型材类型	规格	重量(g/pcs)
XCCB01	308	3020	13.4
		3050	34.2
		3080	54.0
		4520	26.8
		4550	67.0
		4580	107.0
		3520	20.9
		3550	52.0
		3580	83.0
		5520	46.0
		5550	114.0
		5580	182.0
		5020	40.0
		5050	101.0
		5080	161.0
		6020	48.3
6050	123.0		

系列码	型材类型	规格	重量(g/pcs)
XCCB01	308	6080	196.0
		8020	76.0
		8050	188.0
		8080	301.0
		80B20	91.0
		80B50	288.0
		80B80	365.0
		9020	165.0
		9050	231.0
		9080	370.0
		80A20	58.0
		80A50	145.0
		80A80	232.0
		70A20	66.0
		70A50	170.0
		70A80	264.0

加工项目/配置附件

加工项目/配置附件	代码	技术说明
截面螺纹孔加工	S	<p>在角座侧面上加工安装面板用的螺纹孔(单面M5螺纹孔深度15mm)。</p> <p>螺纹孔位置</p>
适配螺栓, 滑块螺母和垫片	SG	<p>螺栓: YWE02-M6-L16</p> <p>滑块螺母: XCNE47-306-M6</p> <p>垫片: YWS02-6</p>

加工项目/配置附件指定方法, 见订货范例。

XCCB01-308-3020-S

系列码	型材类型	规格	加工项目/配置附件
XCCB01	308	3020	S

请按图示订货

交期Delivery

5天

发货

○本产品发货时间不含周日

使用示例:

