

欧标40槽10系列 ◀ 连接配件

挤压角码

系列码	材质	表面处理
XCCB01	A6063-T5	喷砂氧化

■用于型材固定角度的外连接，可固定封板。

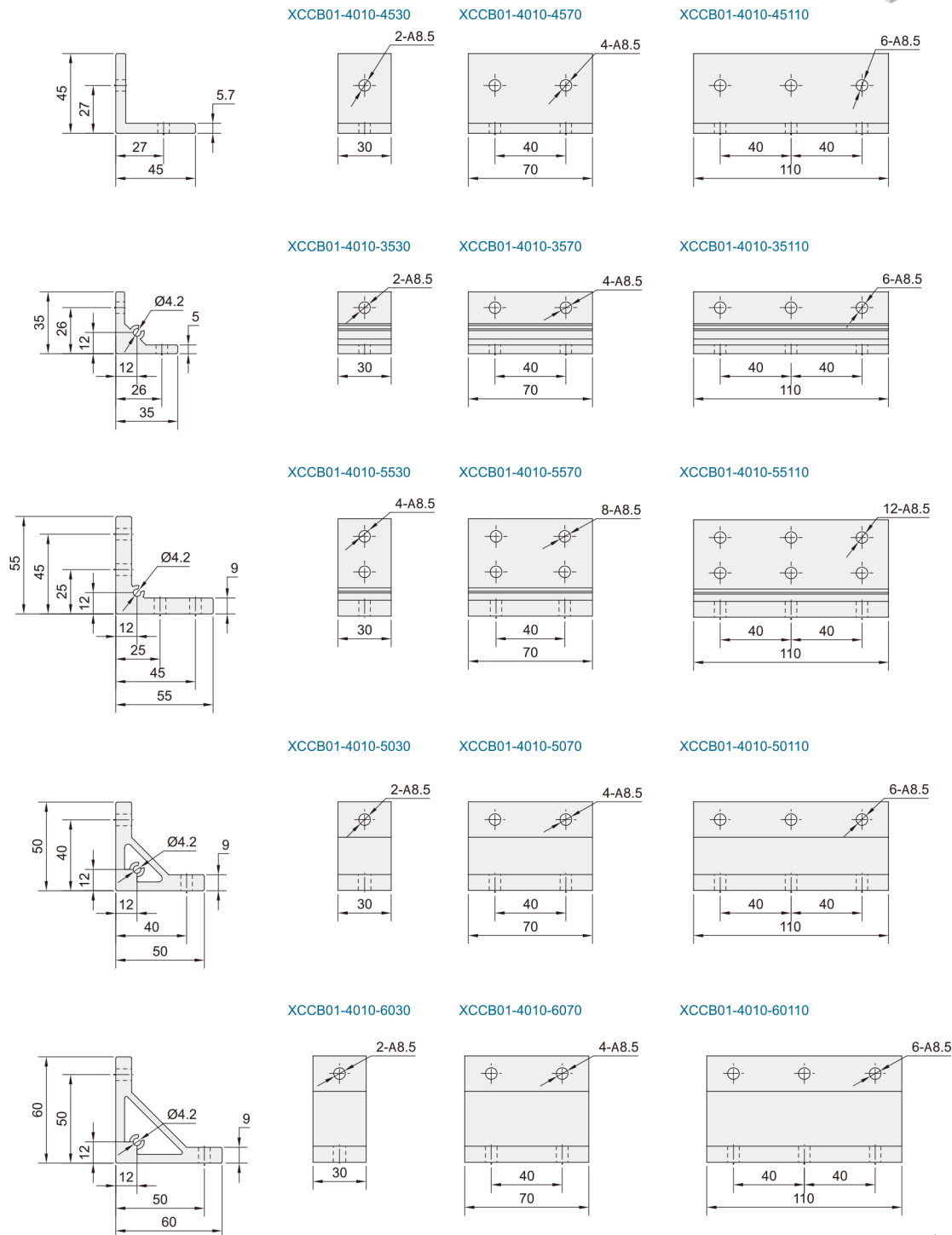

视图标准：第三视角

XCCB01-4010-8030

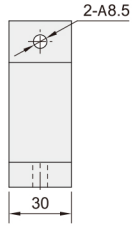
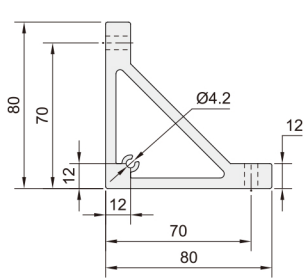

XCCB01-4010-8070

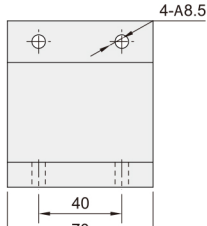
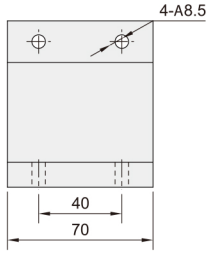

XCCB01-4010-80110

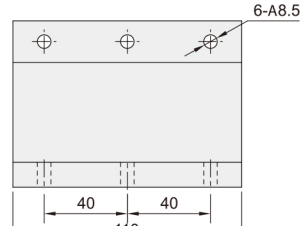
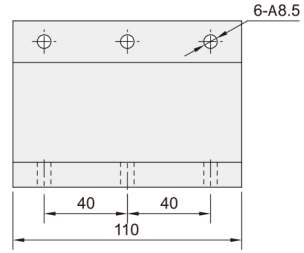

XCCB01-4010-80B30

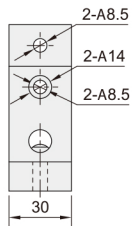
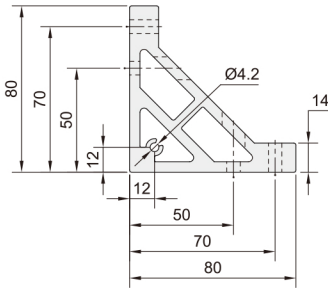

XCCB01-4010-80B70

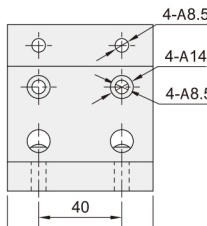
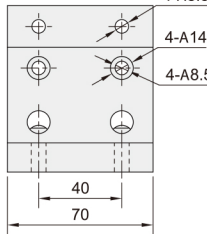

XCCB01-4010-80B110

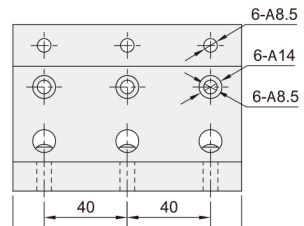
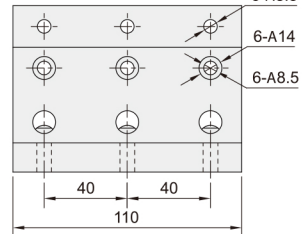

XCCB01-4010-9030

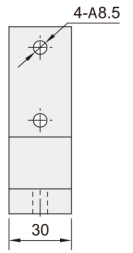
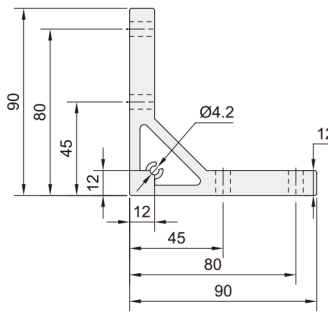

XCCB01-4010-9070

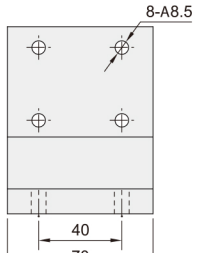
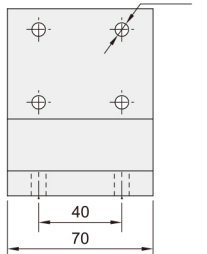

XCCB01-4010-90110

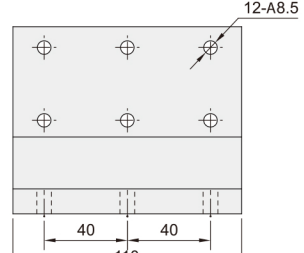
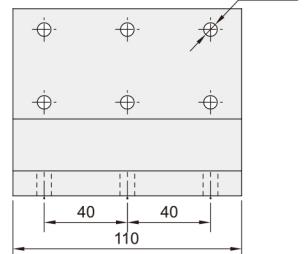

XCCB01-4010-80A30

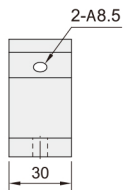
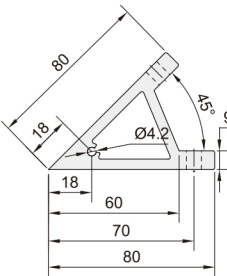

XCCB01-4010-80A70

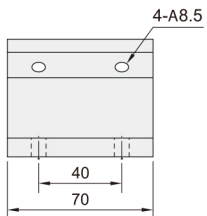
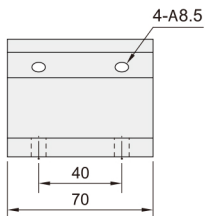

XCCB01-4010-80A110

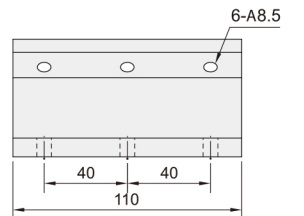
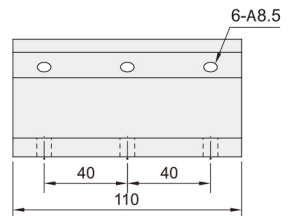

XCCB01-4010-70A30

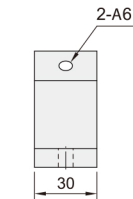
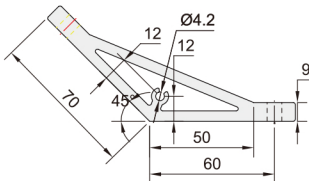

XCCB01-4010-70A70

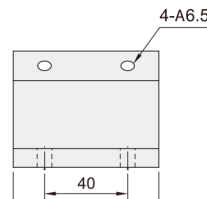
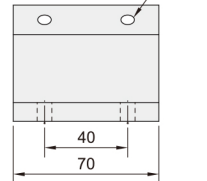

XCCB01-4010-70A110

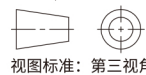
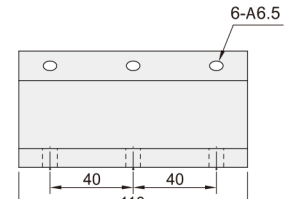
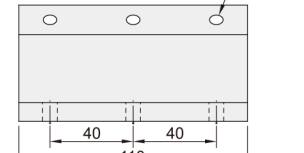

视图标准：第三视角

系列码	型材类型	规格	重量(g/pcs)
XCCB01	4010	4530	25.20
		4570	58.00
		45110	92.00
		3530	30.90
		3570	72.00
		35110	113.00
		5530	68.00
		5570	160.00
		55110	250.00
		5030	60.00
		5070	141.00
		50110	222.00
		6030	73.00
		6070	169.00
		60110	266.00

系列码	型材类型	规格	重量(g/pcs)
XCCB01	4010	8030	113.00
		8070	264.00
		80110	415.00
		80B30	137.00
		80B70	320.00
		80B110	503.00
		9030	140.00
		9070	323.00
		90110	510.00
		80A30	87.00
		80A70	203.00
		80A110	319.00
		70A30	100.00
		70A50	235.00
		70A110	369.00



请按图示订货

■ XCCB01-4010-4040-SE

系列码	型材类型	规格	加工项目/配置附件
XCCB01	4010	3530	SE



交期Delivery

5天

发货

○本产品发货时间不含周日

■加工项目/配置附件

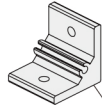
加工项目/配置附件	代码	说明
截面螺纹孔加工	S	 攻牙M5深15
适配螺栓, T型螺母和垫片	SE	螺栓: YWE02-M8-L16 F型螺母: XCNA45-4010-M8 垫片: YWS02-8

■加工项目/配置附件指定方法, 见订货范例。

使用示例:

