

DCB42-CSCA 节流阀

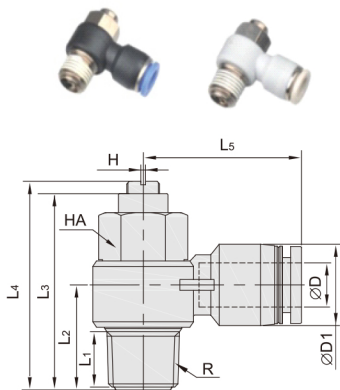

型号	ΦD	R	L ₁	L ₂	L ₃	L ₄	L ₅	ΦD1	H	HA
DCB42-CSCA04-M5	4	M5	3.2	10.5	23	23.5	20.3	11.3	0.5	8
DCB42-CSCA04-01		R1/8	7	15	29	32	23		0.8	12
DCB42-CSCA04-02		R1/4	11	18.5	34.8	37.5	25.2		1.2	14
DCB42-CSCA06-M5	6	M5	3.2	11.5	23	23.5	21.8	13.3	0.5	8
DCB42-CSCA06-01		R1/8	7	15	29	32	23		0.8	12
DCB42-CSCA06-02		R1/4	11	18.5	34.8	37.5	25		1.2	14
DCB42-CSCA06-03		R3/8	12.5	22	40.8	43.5	26.7		1.9	19
DCB42-CSCA06-04	R1/2	15	26	46.6	51	32	1.6	24		
DCB42-CSCA08-01	8	R1/8	7	15.8	29	32	25.8	15	0.8	12
DCB42-CSCA08-02		R1/4	11	19.5	34	37.5	28.9		1.2	14
DCB42-CSCA08-03		R3/8	12.5	21.3	40.8	43.5	29.8		1.9	19
DCB42-CSCA08-04		R1/2	15	26	46.6	51	32.8		1.6	24
DCB42-CSCA10-01	10	R1/8	7	17.5	29	32	30.3	19	0.8	12
DCB42-CSCA10-02		R1/4	11	21.2	34.8	37.5	32.7		1.2	14
DCB42-CSCA10-03		R3/8	12.5	23.2	40.8	43.5	33		1.6	19
DCB42-CSCA10-04		R1/2	15	26.2	46.6	51	36		1.6	24
DCB42-CSCA12-02	12	R1/4	11	22.5	34.8	37.5	33.5	21.5	1.2	14
DCB42-CSCA12-03		R3/8	12.5	24.5	40.8	43.5	35.5		1.2	19
DCB42-CSCA12-04		R1/2	15	27.5	46.6	51	36.5		1.6	24

DCB43-CSCD 大流节流阀

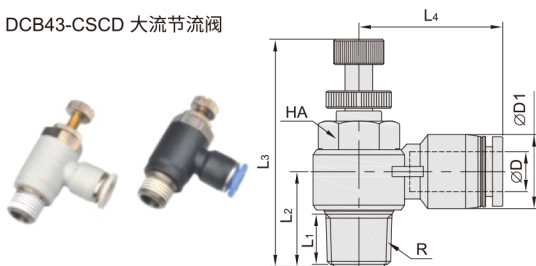

型号	ΦD	R	L ₁	L ₂	L ₃	H	ΦD1	HA
DCB43-CSCD04-M5	4	M5	3.5	16	39	20	13	8
DCB43-CSCD06-M5		M5	3.5	15	39	22	13	8
DCB43-CSCD06-01	6	R1/8	7.5	21	49	23	11.5	14
DCB43-CSCD06-02		R1/4	9.5	26.5	57	25	11.5	17
DCB43-CSCD08-01	8	R1/8	7.5	22	49	25.5	14.5	14
DCB43-CSCD08-02		R1/4	9.5	26.5	57	27.5	14.5	17

DCB51-CSPC 截止阀

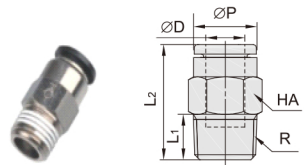

型号	ΦD	R	L ₁	L ₂	ΦP	HA
DCB51-CSPC04-01	4	R1/8	7.5	27.5	10	10
DCB51-CSPC06-01		R1/8	7.5	27	12	12
DCB51-CSPC06-02	6	R1/4	9.5	27	14	14
DCB51-CSPC08-01		R1/8	7.5	29	14	14
DCB51-CSPC08-02	8	R1/4	9.5	29	14	14
DCB51-CSPC08-03		R3/8	10.5	29	14	17

型号	ΦD	R	L ₁	L ₂	ΦP	HA
DCB51-CSPC10-02	10	R1/4	9.5	37	17	17
DCB51-CSPC10-03		R3/8	10.5	37	17	17
DCB51-CSPC10-04	10	R1/2	13.5	37	17	17
DCB51-CSPC12-02		R1/4	9.5	37	17	17
DCB51-CSPC12-03	12	R3/8	10.5	38	20	21
DCB51-CSPC12-04		R1/2	13.5	38	20	21

DCB52-CSPL 截止阀

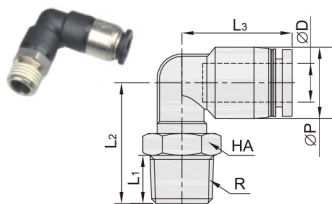

型号	ΦD	R	L ₁	L ₂	L ₃	ΦP	HA
DCB52-CSPL04-M5	4	M5	3.5	21.3	31	13	10
DCB52-CSPL04-M6		M6	4	21.8			
DCB52-CSPL04-01		R1/8	7.5	23.8			
DCB52-CSPL06-M5	6	M5	3.5	21.7	29.4	13	12
DCB52-CSPL06-M6		M6	4	22.2			
DCB52-CSPL06-01		R1/8	7.5	24.2			
DCB52-CSPL06-02		R1/4	9.5	26.7			
DCB52-CSPL08-01	8	R1/8	7.5	27.5	33	14.5	14

型号	ΦD	R	L ₁	L ₂	ΦP	HA
DCB52-CSPL08-02	8	R1/4	9.5	29.5	33	14.5
DCB52-CSPL08-03		R3/8	10.5	31		
DCB52-CSPL10-02	10	R1/4	9.5	34.3	42.5	18
DCB52-CSPL10-03		R3/8	10.5	35.3		
DCB52-CSPL10-04	10	R1/2	13.5	38.8	46.5	21
DCB52-CSPL12-02		R1/4	9.5	36		
DCB52-CSPL12-03	12	R3/8	10.5	37	46.5	21
DCB52-CSPL12-04		R1/2	13.5	40		

DCB53-CSPU 截止阀

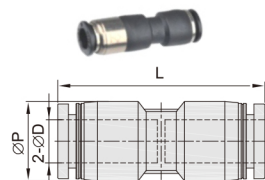

型号	ΦD	R	L ₁
DCB53-CSPU04	4	13	47
DCB53-CSPU06	6	13	46
DCB53-CSPU08	8	15	49.5
DCB53-CSPU10	10	19	63
DCB53-CSPU12	12	21.5	66.5

DCB54-CPCVF 单向阀

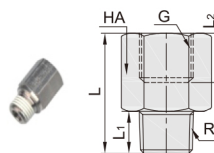

型号	R	G	L ₁	L ₂	L	HA
DCB54-CPCVF01-01	R1/8	G1/8	7.5	8.5	23	14
DCB54-CPCVF02-02	R1/4	G1/4	9.5	11	29.8	17
DCB54-CPCVF03-03	R3/8	G3/8	10.5	12	32.9	21
DCB54-CPCVF04-04	R1/2	G1/2	13.5	14	37	24