

# 松下FP/FPO专用端子台-MTA

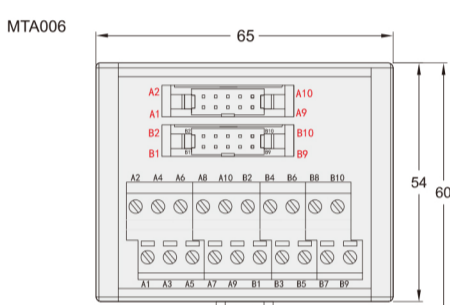

额定值/性能			
额定电流	1A		
额定电压	DC24V		
适合电线	1.5mm <sup>2</sup> /AWG16以下		
系列码	端子台	搭配PLC型号	适用电缆线
DZC11	MTA003	Fp0-C32P/C32CP/T32CP(IN) Fp0-E16T/P(IN) Fp0-E32T/P(IN) Fp0-E8X Fp0-E16X FpΣ-C28(IN) FpΣ-C32(IN)	DX216-1 DX216-2
	MTA003B	Fp0-C16T/C16CT(OUT) Fp0-C16P/C16CP(OUT) Fp0-C32T/C32CT/T32CT(OUT) Fp0-C32P/C32CP/T32CP(OUT) Fp0-E16T/P(OUT) Fp0-E32T/P(OUT) Fp0-E8YT Fp0-E16YT FpΣ-C28(OUT) FpΣ-C32(OUT)	
DZC12	MTA006	Fp0-C16T/C16CT(OUT) Fp0-C6P/C16CP(OUT) Fp0-C32T/C32CT/T32CT(OUT) Fp0-C32P/C32CP/T32CP(OUT) Fp0-E16T/P(OUT) Fp0-E8YT Fp0-E16YT FpΣ-C28(OUT) FpΣ-C32(OUT)	
DZC13	MTA005	Fp0-C16T/C16CT(OUT) Fp0-C6P/C16CP(OUT) Fp0-C32T/C32CT/T32CT(OUT) Fp0-C32P/C32CP/T32CP(OUT) Fp0-E16T/P(OUT) Fp0-E8YT Fp0-E16YT FpΣ-C28(OUT) FpΣ-C32(OUT)	

外形图

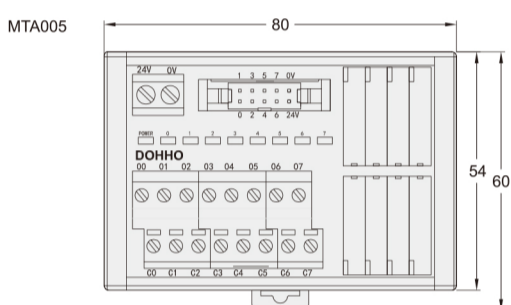
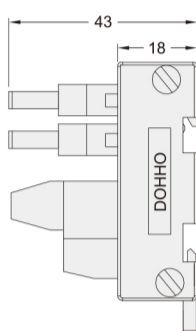
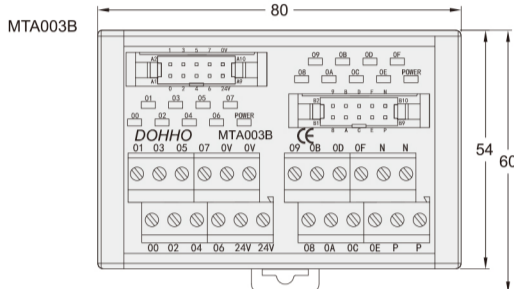
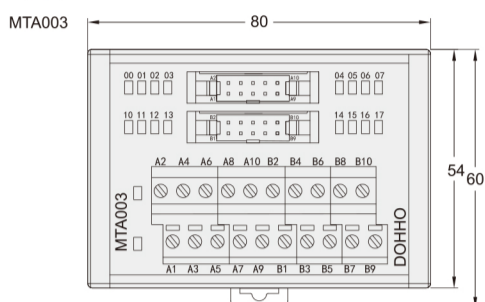

[www.vipdo.cn](http://www.vipdo.cn) 400-098-1117 工厂自动化零件一站式采购平台

汇集国内外知名品牌, 让采购更便捷, 让设计更高效!

# 松下FP/FPO专用端子台-MTA

电路图 MTA003

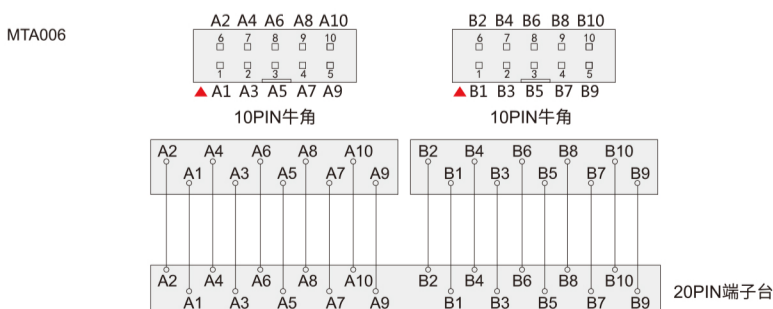
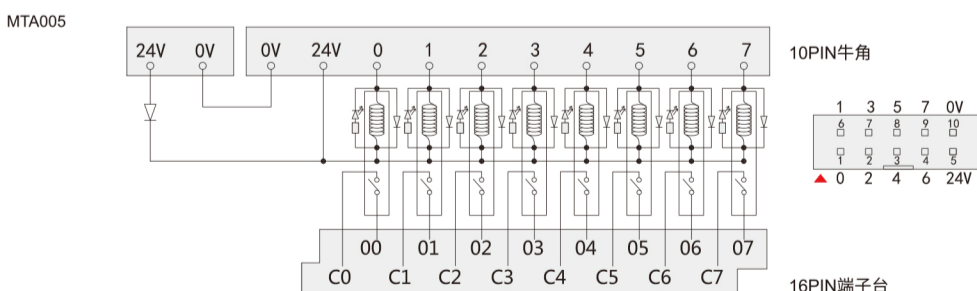
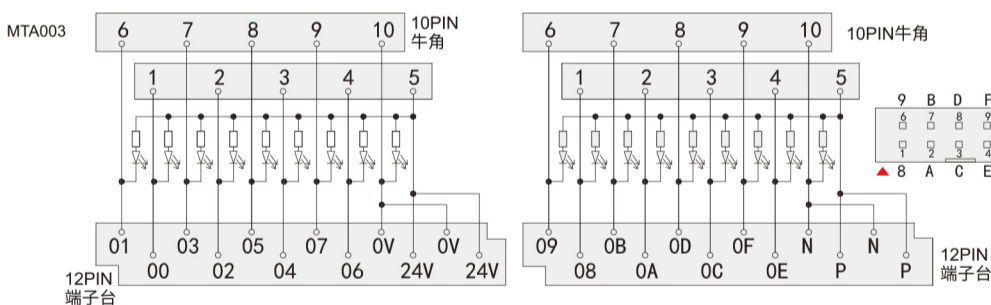
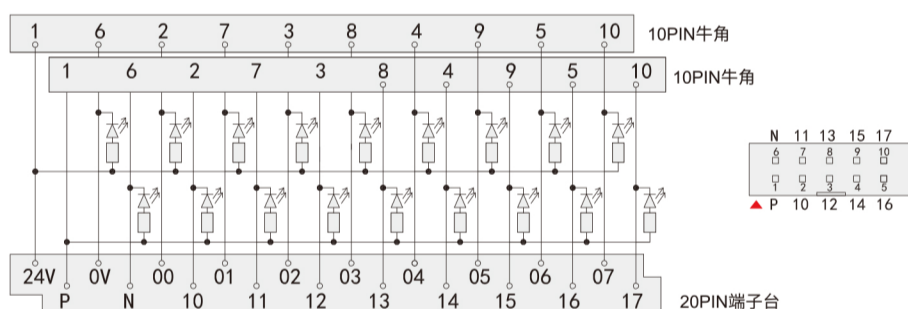

请按图示订货

## ■ DZC11-MTA003

型号  
代码 端子台型号  
DZC11 MTA003



交期Delivery

5天 发货

○本产品发货时间不含周日

[www.vipdo.cn](http://www.vipdo.cn) 400-098-1117 工厂自动化零件一站式采购平台

汇集国内外知名品牌, 让采购更便捷, 让设计更高效!