

PLEK系列减速机



减速机核心特性:

- ①采用直齿齿轮传动，经渗碳淬火处理，齿向齿廓修形处理，确保运行平稳，噪音小；
- ②结构简单，可大批量生产，且交货期快性价比高；
- ③减速机种类齐全，可以满足市场上绝大多数减速机的配合。

代码	型号
ZDX13	PLEK60
	PLEK90
	PLEK120

PLEK60-L1

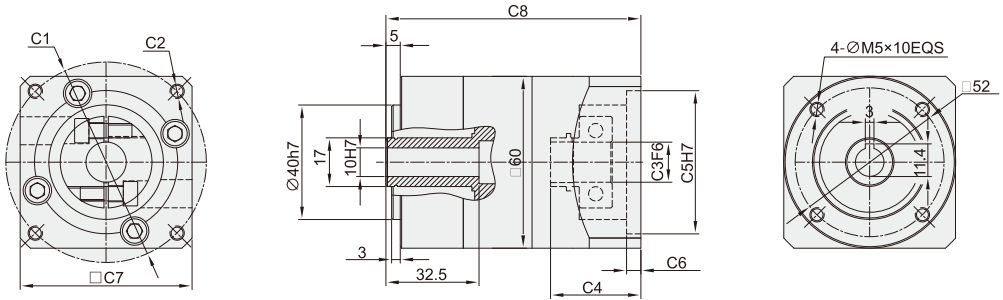

PLEK60-L2

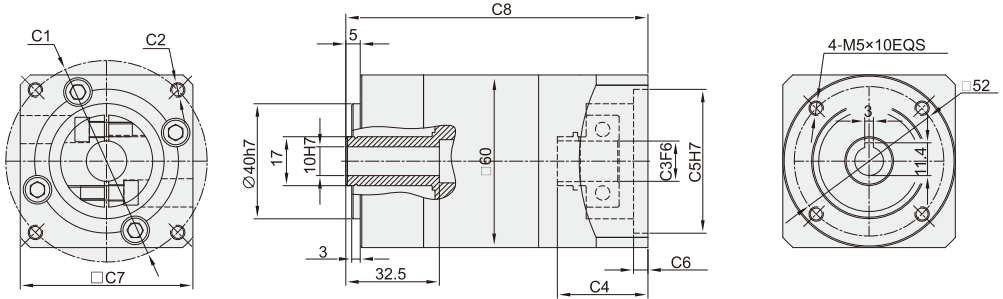

PLEK60-L3

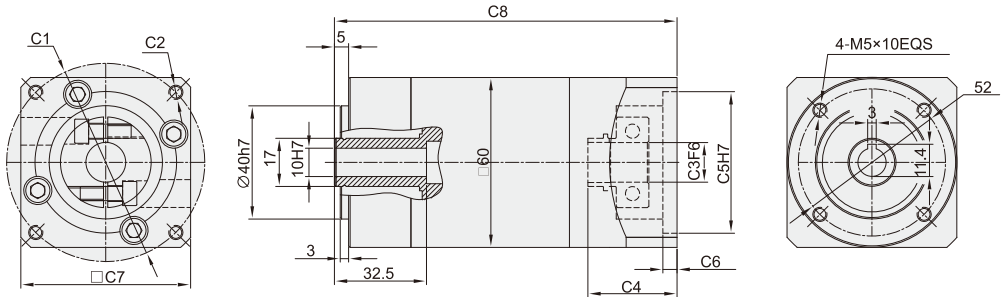

PLEK90-L1

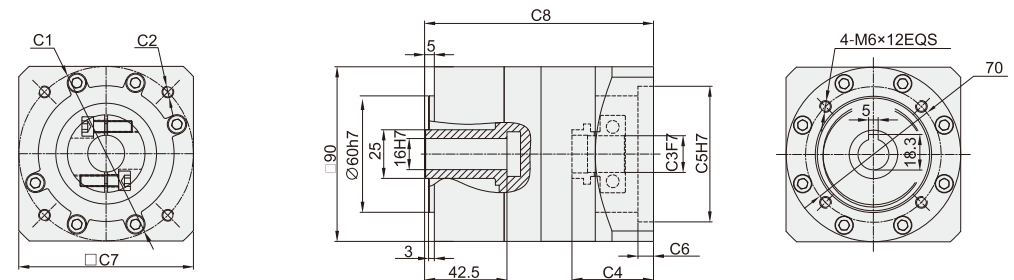

PLEK系列减速机

PLEK90-L2

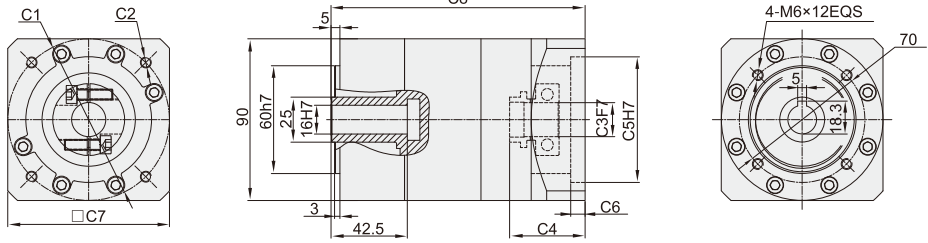

PLEK90-L3

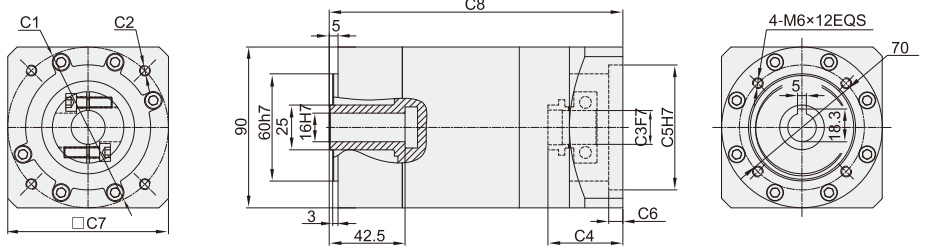

PLEK120-L1

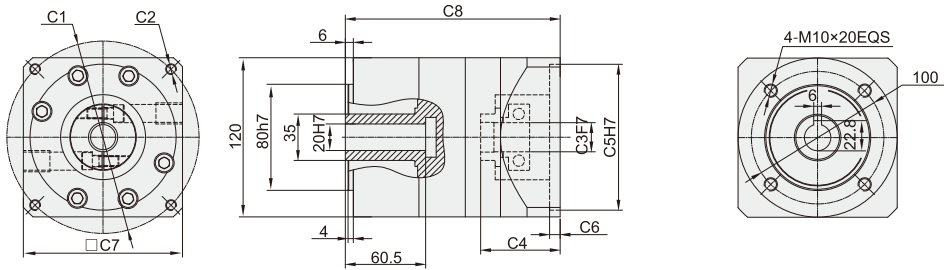

PLEK120-L2

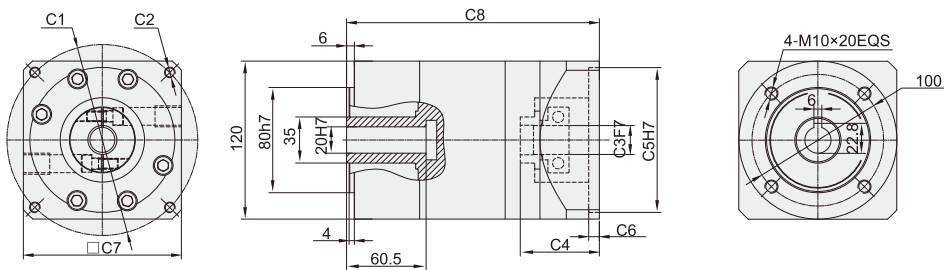

PLEK120-L3

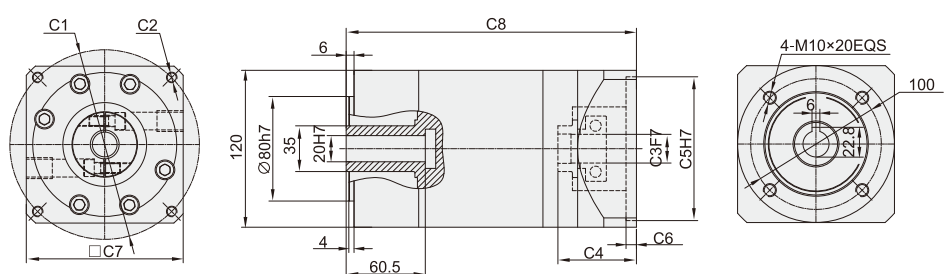

PLEK系列减速机

尺寸	M	C1	C2	C3	C4	C5	C6	C7	C8
PLEK60-L1	M1	Φ66.67	4-M4	Φ8	31.5	Φ38.1	5.0	60	89
	M2	Φ70	4-M4	Φ14	31.5	Φ50	5.0	60	89
	M3	Φ70	4-M5	Φ14	31.5	Φ50	5.0	60	89
PLEK60-L2	M1	Φ66.67	4-M4	Φ8	31.5	Φ38.1	5.0	60	105
	M2	Φ70	4-M4	Φ14	31.5	Φ50	5.0	60	105
	M3	Φ70	4-M5	Φ14	31.5	Φ50	5.0	60	105
PLEK60-L3	M1	Φ66.67	4-M4	Φ8	31.5	Φ38.1	5.0	60	121
	M2	Φ70	4-M4	Φ14	31.5	Φ50	5.0	60	121
	M3	Φ70	4-M5	Φ14	31.5	Φ50	5.0	60	121
PLEK90-L1	M1	Φ98.5	4-M6	Φ14	42	Φ73	8.0	80	118
	M2	Φ90	4-M5	Φ19	42	Φ70	8.0	80	118
	M3	Φ90	4-M6	Φ19	42	Φ70	8.0	80	118
PLEK90-L2	M1	Φ98.5	4-M6	Φ14	42	Φ73	8.0	80	141.5
	M2	Φ90	4-M5	Φ19	42	Φ70	8.0	80	141.5
	M3	Φ90	4-M6	Φ19	42	Φ70	8.0	80	141.5
PLEK90-L3	M1	Φ98.5	4-M6	Φ14	42	Φ73	8.0	80	164.5
	M2	Φ90	4-M5	Φ19	42	Φ70	8.0	80	164.5
	M3	Φ90	4-M6	Φ19	42	Φ70	8.0	80	164.5
PLEK120-L1	M1	Φ115	4-M8	Φ19	60	Φ95	8	120	162
	M2	Φ115	4-M8	Φ22	60	Φ95	8	120	162
	M3	Φ130	4-M8	Φ19	60	Φ95	8	120	162
	M4	Φ130	4-M8	Φ22	60	Φ95	8	120	162
	M5	Φ145	4-M8	Φ19	60	Φ110	8	120	162
	M6	Φ145	4-M8	Φ22	60	Φ110	8	120	162
	M7	Φ145	4-M8	Φ24	60	Φ110	8	120	162
PLEK120-L2	M1	Φ115	4-M8	Φ19	60	Φ95	8	120	192
	M2	Φ115	4-M8	Φ22	60	Φ95	8	120	192
	M3	Φ130	4-M8	Φ19	60	Φ95	8	120	192
	M4	Φ130	4-M8	Φ22	60	Φ95	8	120	192
	M5	Φ145	4-M8	Φ19	60	Φ110	8	120	192
	M6	Φ145	4-M8	Φ22	60	Φ110	8	120	192
	M7	Φ145	4-M8	Φ24	60	Φ110	8	120	192
PLEK120-L3	M1	Φ115	4-M8	Φ19	60	Φ95	8	120	222
	M2	Φ115	4-M8	Φ22	60	Φ95	8	120	222
	M3	Φ130	4-M8	Φ19	60	Φ95	8	120	222
	M4	Φ130	4-M8	Φ22	60	Φ95	8	120	222
	M5	Φ145	4-M8	Φ19	60	Φ110	8	120	222
	M6	Φ145	4-M8	Φ22	60	Φ110	8	120	222
	M7	Φ145	4-M8	Φ24	60	Φ110	8	120	222

PLEK系列减速机

型号	单位	PLEK60	PLEK90	PLEK120	减速比	阶段
额定输出扭矩	N.m	16.5	60	148	3	L1
		27	86	222	4	
		27	94.5	235	5	
		19.5	64	158	7	
		8.5	39.5	93	10	
		—	96	250	12	L2
		—	96	250	15	
		30	96	250	16	
		30	96	250	20	
		33	105.5	264	25	
		30	96	250	28	L3
		33	105.5	264	35	
		33	105.5	264	50	
		21.5	71.5	177	70	
		37.5	120	310	64	
		37.5	120	310	80	L3
		37.5	120	310	100	
		41.0	132.5	329	125	
		37.5	120	310	140	
		41.0	132.5	329	175	
		37.5	120	310	200	L3
41.0	132.5	329	250			
37.5	120	310	280			
41.0	132.5	329	350			
故障停滞扭矩	N.m	2倍额定输出扭矩				
额定输入转速	rpm	3000	3000	2000		
最大输入转速	rpm	6000	6000	3500		
最大径向力	N	170	1020	2230		—
最大轴向力	N	120	850	1550		
效率	%	单一[97%]		双倍[95%]		
平均寿命	h	20000				
重量	kg	1.4	4.7	6.9	—	L1
		1.6	5.3	8.9	—	L2
		1.8	5.9	11.2	—	L3
转动惯量	kgcm ²	0.107	0.4	1.65	3	L1
		0.094	0.309	1.22	4	
		0.092	0.291	1.15	5	
		0.091	0.285	1.13	7	
		0.091	0.283	1.11	10	
		—	0.4	1.65	12	L2
		—	0.309	1.65	15	
		0.094	0.291	1.22	16	
		0.092	0.291	1.15	20	
		0.092	0.291	1.15	25	
		0.091	0.285	1.13	28	L2
		0.091	0.285	1.13	35	
		0.091	0.2835	1.11	40	
		0.091	0.283	1.11	50	
		0.091	0.283	1.11	70	
		0.092	0.291	1.15	64	L3
		0.092	0.291	1.15	80	
		0.092	0.291	1.15	100	
		0.092	0.291	1.15	125	
		0.091	0.291	1.13	140	
		0.091	0.291	1.13	175	L3
0.091	0.283	1.11	200			
0.091	0.283	1.11	250			
噪音	dB	60	65	68		—
润滑		合成油脂润滑				
防护等级		Ip65				

减速机

07



请按图示订货

■ ZDX13-PLEK60-L1-10-S2-M1

代码	减速机系列名称	减速比	输出方式	电机尺寸	可选
ZDX13	PLEK60-L1	10	S1:无输出轴键 S2:附带输出轴键	M1 M2 M3	T:输入端 开键槽



交期Delivery

3天

发货

○本产品发货时间不含周日

www.vipdo.cn 400-098-1117 工厂自动化零件一站式采购平台