

输入/输出端子台-MTM ◀ 12/16位

MTM120
MTM120-P



MTM160
MTM160-P



MTM121
MTM121-P



MTM161
MTM161-P



额定值/性能				
额定电流	1A			
额定电压	DC24V			
适合电线	1.5mm ² /AWG16以下			
系列码	JDZE05	JDZE06	JDZE07	JDZE08
端子台	MTM120 MTM120-P	MTM121 MTM121-P	MTM160 MTM160-P	MTM161 MTM161-P
名称	12位输入端子台		16位输入端子台	

MTM120\MTM120-P

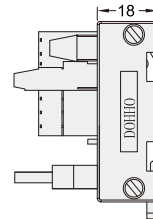
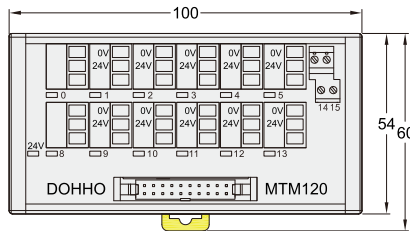

MTM121\MTM121-P

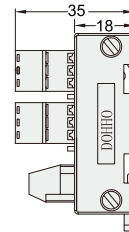
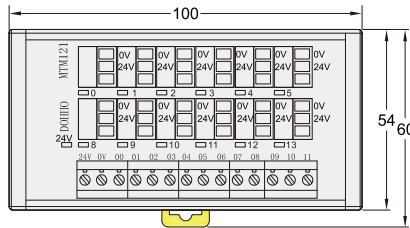

MTM160\MTM160-P

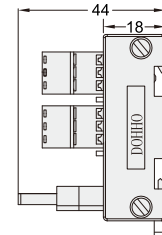
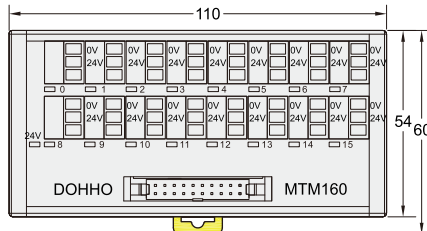

MTM161\MTM161-P

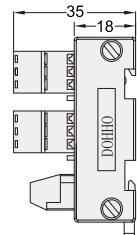
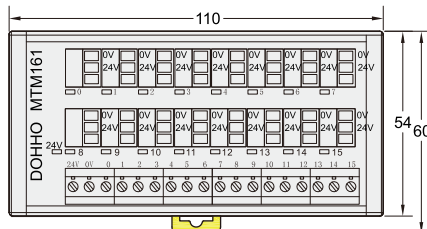

端子台
断路器

14



请按图示订货

JDZE05-MTM120

型号	
代码	端子台型号
JDZE05	MTM120



交期Delivery

5天 发货

○本产品发货时间不含周日

www.vipdo.cn 400-098-1117 工厂自动化零件一站式采购平台

输入/输出端子台-MTM ◀ 12/16位

电路图

MTM120

20PIN牛角

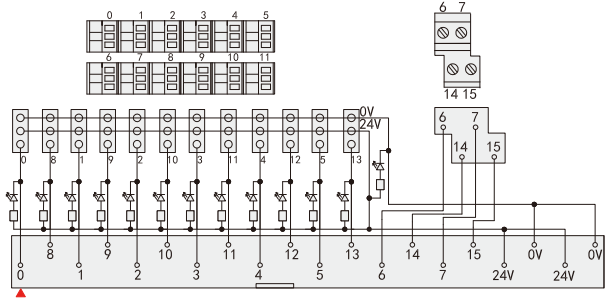
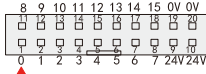

MTM120-P

20PIN牛角

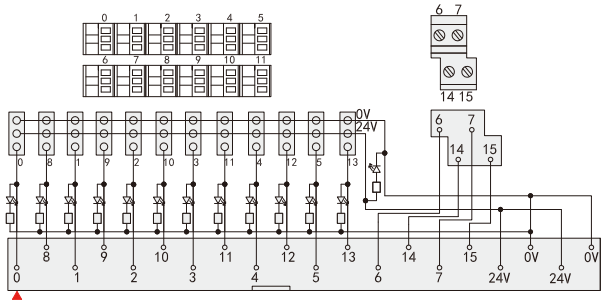

MTM121

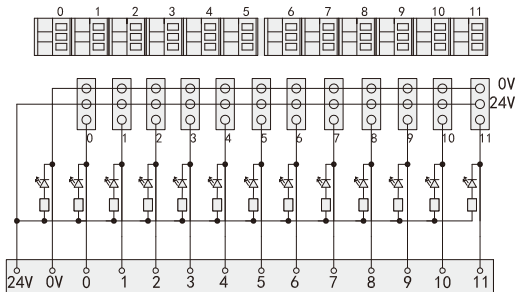

MTM121-P

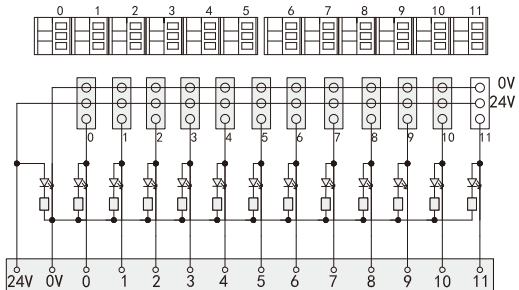

断
端
子
台

14

输入/输出端子台-MTM ◀ 12/16位

电路图

MTM160

20PIN牛角

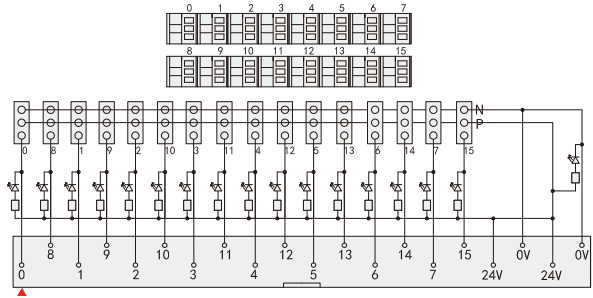
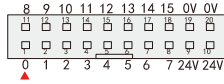

MTM160-P

20PIN牛角

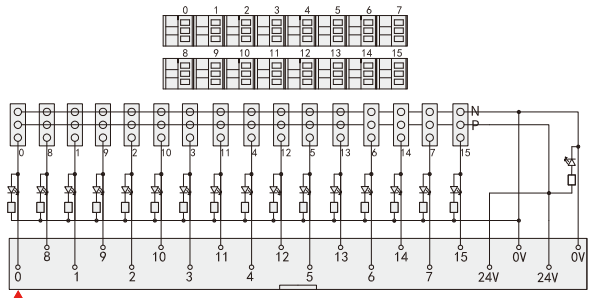
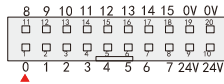

MTM161

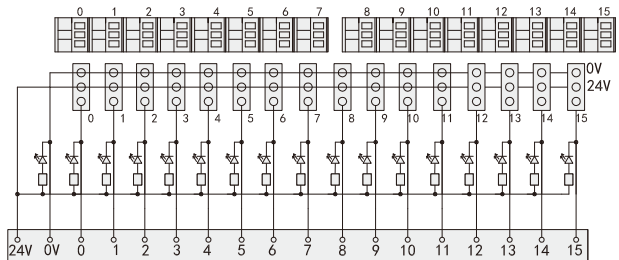
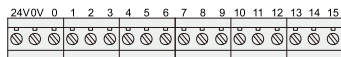

MTM161-P

