

电感式接近开关 ◀ N2G 系列方形接近开关/小方形

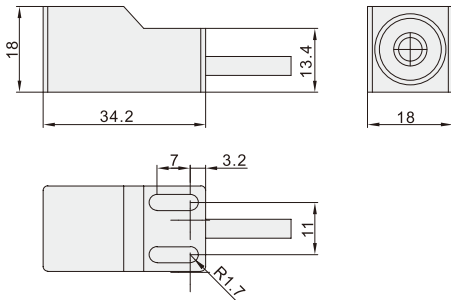

代码	检测方式	连接方式	输出状态	输出	型号		
JEAP02	顶端检测	导线引出型	NPN输出	NO	N2G-H5NA	N2G-H8NA	N2G-F5NA
				NC	N2G-H5PA	N2G-H8PA	N2G-F5PA
			PNP输出	NO	N2G-H5NB	N2G-H8NB	N2G-F5NB
				NC	N2G-H5PB	N2G-H8PB	N2G-F5PB

N2G-H



N2G-F

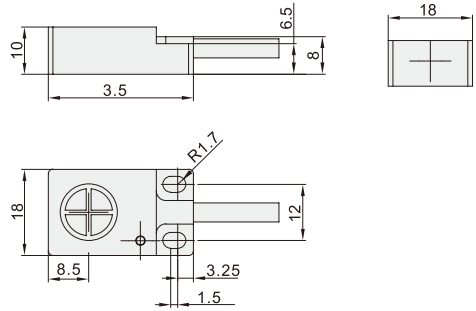















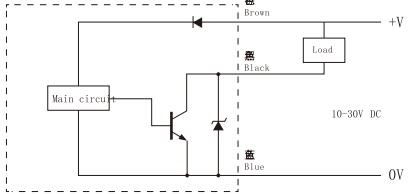







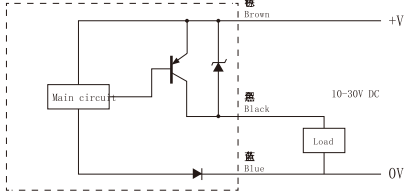

JEAP02	NO	NPN输出		型号	N2G-H5NA	N2G-H8NA	N2G-F5NA
		PNP输出			N2G-H5PA	N2G-H8PA	N2G-F5PA
	NC	NPN输出		型号	N2G-H5NB	N2G-H8NB	N2G-F5NB
		PNP输出			N2G-H5PB	N2G-H8PB	N2G-F5PB
检测距离					5mm±10%	8mm±10%	5mm±10%
设定距离					0~4mm	0~7mm	0~4mm
公差					检出距离的10%以下		
检测物体					磁性金属(非磁性金属时检测距离减小)		
响应频率					铁:15×15×1mm		
电源电压					500Hz		
消耗电流					DC12-30V±10%		
控制输出					10mA(max)		
指示灯					开关容量:50mA以下; 残留电压:1V以下(负载电流50mA, 导线长2M时)		
保护电路					动作显示灯(红色)		
环境温度					逆向连接保护、浪涌吸收		
环境湿度					动作时、保存时:各-25°C~+70°C(不结冰、结露)		
温度影响					动作时、保存时:35%~95%RH, 不结露		
电压影响					温度范围-25~+70°C,+23°C时, ±20%检测距离以内		
绝缘电阻					额定电源电压范围±10%以内、额定电源电压值时, ±2.5%检测距离以内		
耐电压					50MΩ以上(DC500V兆欧表) 充电部整体与外壳间		
耐振动					AC500V, 50/60Hz, 1min充电部与外壳间		
耐冲击					10~55Hz上下振幅1.5mmX/Y/Z各方向2h		
防护等级					200m/s²x/Y/Z各方向10次		
连接方式					IP67		
材料					导线引出型(标准线长:2m) 耐热ABS		

电感式接近开关 ◀ N2G 系列方形接近开关/小方形

传
感
器

11

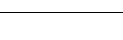
输出模式	动作模式	时序图	输出回路图
NPN	OUT: NO常开	<p>检测物体</p> <p>有 </p> <p>无 </p> <p>动作显示灯(绿)</p> <p>灯亮 </p> <p>灯灭 </p> <p>控制输出(棕-黑间)</p> <p>ON </p> <p>OFF </p>	
	OUT: NC常闭	<p>检测物体</p> <p>有 </p> <p>无 </p> <p>动作显示灯(绿)</p> <p>灯亮 </p> <p>灯灭 </p> <p>控制输出(棕-黑间)</p> <p>ON </p> <p>OFF </p>	
PNP	OUT: NO常开	<p>检测物体</p> <p>有 </p> <p>无 </p> <p>动作显示灯(绿)</p> <p>灯亮 </p> <p>灯灭 </p> <p>控制输出(棕-黑间)</p> <p>ON </p> <p>OFF </p>	
	OUT: NC常闭	<p>检测物体</p> <p>有 </p> <p>无 </p> <p>动作显示灯(绿)</p> <p>灯亮 </p> <p>灯灭 </p> <p>控制输出(棕-黑间)</p> <p>ON </p> <p>OFF </p>	



请按图示订货

JEAP02-N2G-H5NA

代码	型号
JEAP02	N2G-H5NA



交期Delivery

4天 发货

○本产品发货时间不含周日