

# 方形丝杠支座组件 ◀ 固定侧 精密型/标准型



代码	类型	材质		表面处理	
		① ③ ④ ⑥	S50C	① ③ ④ ⑥	发黑
HAB41	精密型	固定侧			
HAB42	标准型				

代号	零件名称	数量
①	轴承座本体	1
②	轴承	1对
③	轴承盖	1
④	间隔环	2
⑤	内六角紧定螺丝	2
⑥	支座用螺母	1
⑦	油封 (φ8以下1个)	2

d6~8

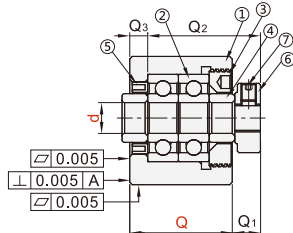
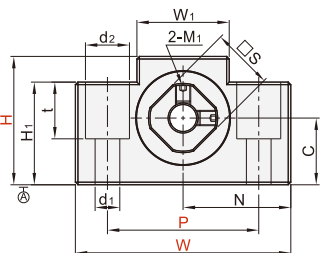

d10~15

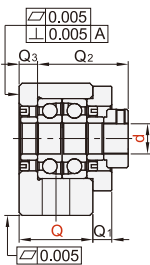
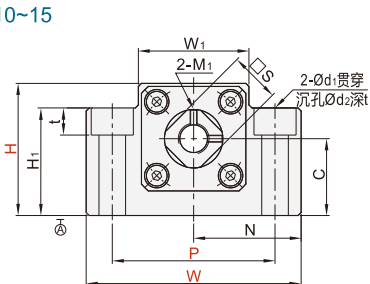

d20

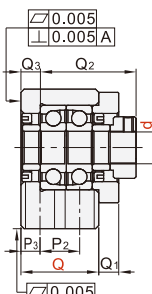
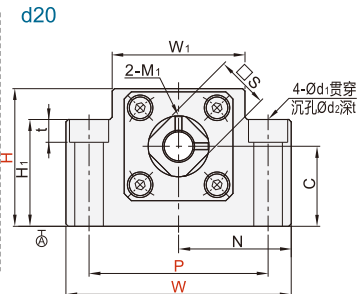

d25

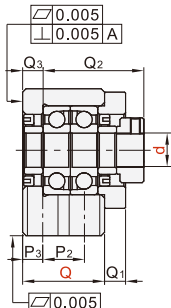
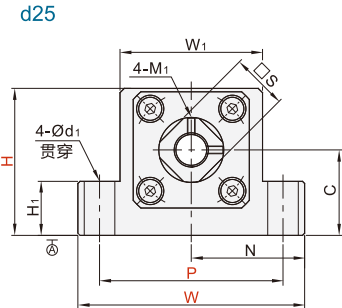

参考轴端加工尺寸

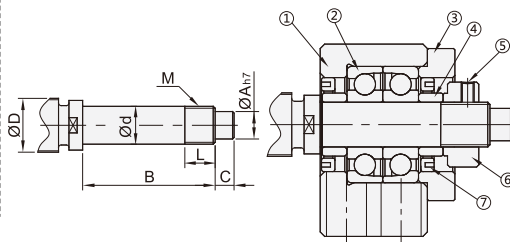

型号	代码	规格	Ød	Q	Q1	Q2	Q3	W	W1	H	H1	N	C	P	P2	P3	Ød1	Ød2	t	M1	S	建议轴端加工尺寸								
																						ØD	Ød	ØA	B	C	M	L		
HAB41	HAB42	10	10	24	29.5	6	70	36	43	35	35	±0.02	25	52	\\	\\	9	14	11	M3	16	12/14/15	10	-0.005 -0.012	8	36	15	M10xP1.0	11	
		12	12	6	38	5	80	41	50	40	40	0	-0.020	60	\\	\\	11	17	15	M4	19	14/15/16	12	-0.005 -0.012	10	49	20	M12xP1.0		
		15	15	25	52	10	95	56	58	45	47.5	30	75	22	10	\\	\\	11	17	15	M4	22	18/20	15	-0.005 -0.014	12	49	20		M15xP1.0
HAB42	HAB42	20	20	42	52	10	95	56	58	45	47.5	30	75	22	10	\\	\\	11	17	15	M4	30	25/28/32	20	-0.005 -0.014	17	64	25	M20xP1.0	17
		25	25	48	59	14	105	66	68	25	52.5	35	85	30	9	\\	\\	11	17	15	M5	35	32/36	25	-0.005 -0.014	22	65	30	M25xP1.5	18

## ■ HAB41-10



请按图示订货

型号		Ød	Q
代码	规格		
HAB41	10	10	24
	12	12	



交期Delivery

**3天** 发货

○本产品发货时间不含周日